

GHG-CSH63 Detent Hinge With Damper

Features

- Detent at both 0° and 100°
- Damper works in either clockwise or counter-clockwise directions
- Also available without damper

Notes

- Ensure both hinge shafts are levelled and aligned during installation

Installation

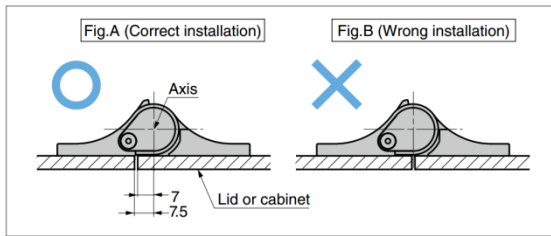

As shown in Fig. A, shift the axis of hinge and the edge of lid or cabinet.

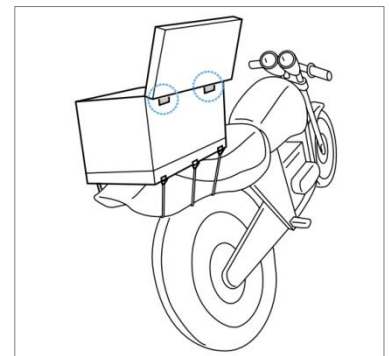
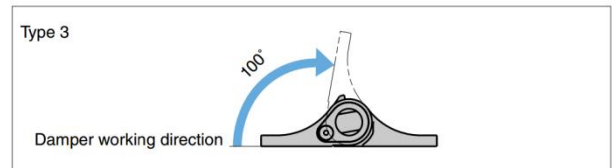
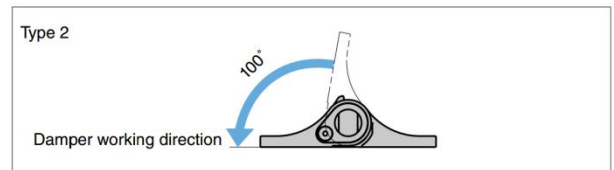
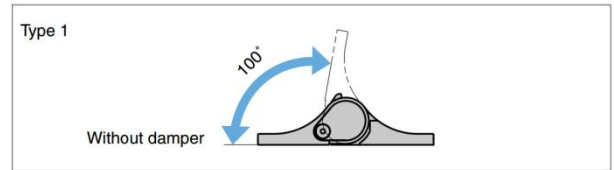
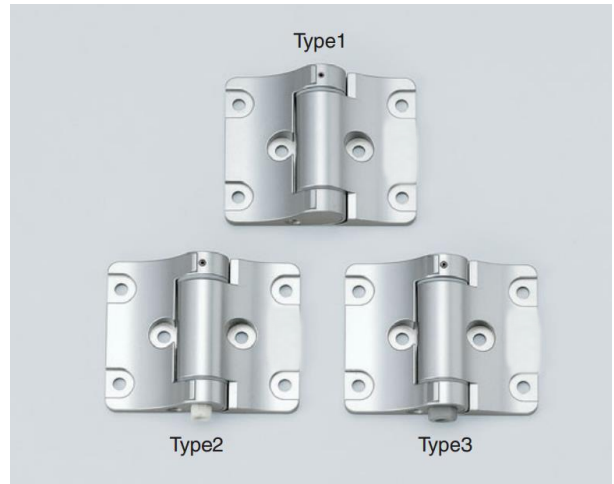
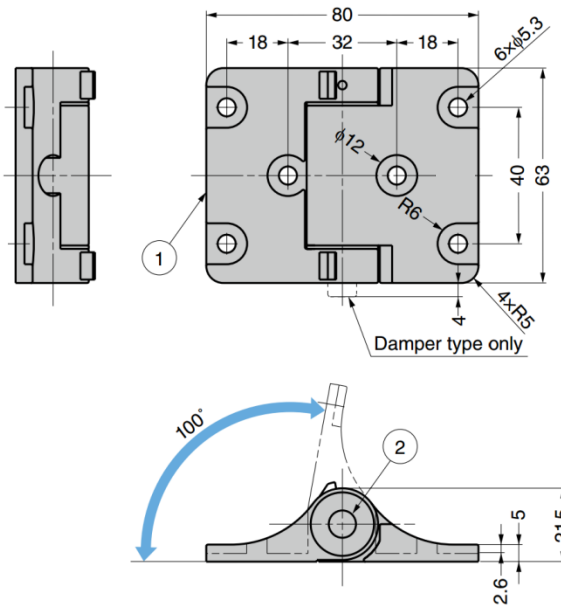

No.	Part Name	Material	Finish / Colour
①	Body	Aluminium Alloy	Silver Enamel Finish
②	Shaft · Spring	Stainless Steel (SUS304)	-

Part No.	Type	Torque (per piece)		Retaining Torque (per piece)	
GHG-CSH63	1 (Without Damper)	-	-		
GHG-CSH63AM	2	1 ~ 1.7 N.m	10.2 ~ 17.3 kgf.cm	0.98 N.m	10 kgf.cm
GHG-CSH63AH		1.7 ~ 2.5 N.m	17.3 ~ 25.5 kgf.cm		
GHG-CSH63BM	3	1 ~ 1.7 N.m	10.2 ~ 17.3 kgf.cm		
GHG-CSH63BH		1.7 ~ 2.5 N.m	17.3 ~ 25.5 kgf.cm		